

# FLAME TAKT

RHYTHM SEQUENCER  
EURO RACK MODULE

USER GUIDE  
Version 1.03



# TABLE OF CONTENTS

3.....	<b>SHORT DESCRIPTION</b>	14.....	<b>RECORDING</b>	24.....	<b>MIDI SETUP</b>
4.....	<b>MODULE OVERVIEW</b>	14.....	SINGLE NOTES	24.....	Track MIDI Receive channel
5.....	<b>CONNECTION TO THE MODULAR SYSTEM</b>	14.....	SHOTS (Note repeat)	24.....	Track MIDI Transmit channel
6.....	<b>CONNECTING THE SENSORS</b>	15.....	VELOCITY RECORDING	24.....	Track MIDI Note numbers
7.....	<b>FUNCTION OF THE SENSORS</b>	15.....	MOD CV RECORDING	24.....	Program change MIDI Receive channel
8.....	<b>TAKT BASIC STRUCTURE</b>	15.....	<b>EDIT PHRASE (Shots Minisequences)</b>	24.....	Program change MIDI Transmit channel
9.....	<b>MAIN MENUS OVERVIEW</b>	15.....	USER PHRASE	24.....	MIDI Clock Receiving
10.....	<b>SEQUENCER DATA STRUCTURE</b>	15.....	EUCLID PHRASE	24.....	MIDI Clock Transmit
10.....	SCENE	16.....	<b>LFO - FUNKTIONS ÜBERBLICK</b>	24.....	DUMP SCENE (Transmit or Receiving)
10.....	PATTERN	17.....	WAVE	25.....	<b>FIRMWARE UPDATE</b>
10.....	FILL PATTERN	19.....	PHASE	26.....	<b>QUICKSTART EXAMPLE</b>
10.....	TRACK	20.....	RATE / SYNC	27.....	<b>TROUBLESHOOTING</b>
10.....	<b>EDIT PATTERN, TRACK, STEPS</b>	21.....	AMP (LFO output level)	28.....	<b>APPENDIX &amp; TECHNICAL INFORMATIONS</b>
10.....	CLEAR, COPY, SWAP	22.....	RANGE (voltage range)		Technical details
11.....	<b>TRACK FUNCTIONS</b>	23.....	<b>SETUP GLOBAL</b>		Warrenty
11.....	HOLD, MUTE	23.....	CV Inputs USER 1+2		Terms of production
11.....	VARIATION	23.....	CLOCK Input		Disposal
12.....	VELO/MOD	23.....	CLOCK Output		Support
12.....	QUANTIZE (Beat Quantize)	23.....	RESET Input		Acknowledgment
13.....	SHUFFLE	23.....	RESET Output		
13.....	TRACKSHIFT	23.....	PATTERN CHANGE		
13.....	LASTSTEP	23.....	AUTO-BAR-COPY		
		23.....	AUTOLOAD SCENE		
		23.....	SUN (Sensor sensitivity)		

# SHORT DESCRIPTION

Thank you for purchasing the FLAME TAKT eurorack module!

“TAKT” is a compact 30TE Eurorack sequencer module for playing trigger/gate/velocity rhythm sequences live. The module is NOT a step sequencer, but a note repeat looper with record functions.

The sequencer has eight tracks with trigger/gate outputs, eight velocity/modulation CV outputs, and full MIDI functionality. The CV track can also be used independently as a modulation track. Live sequencing in looper mode is possible in two ways: SHOTS for playing "note repeats" or quantized triggering using buttons or sensors.

Four tracks each can be triggered simultaneously with four external distance sensors. These sensors are just 2HP narrow modules that can be installed in the rack at desired locations. These are connected directly to the module with narrow and sufficiently long ribbon cables, which also supplies the sensors with the necessary operating voltage. The four sensors and the connection cables are included in the scope of delivery. The sensors generate triggers/gates and can be switched live as a set between tracks 1-4 and 5-8 (e.g. using a foot switch).

Four syncable LFOs with VCOs for amplitude adjustment are also available. The LFOs are equipped with many interesting functions. This includes 26 different waveforms, phase, amplitude, speed and output voltage. These can be unipolar or bipolar (0..+5v or +/-5v) and can also be attenuated via AMP (amplitude) with a built-in VCA. This means that the LFO outputs can also be adapted to modules that do not have an input attenuator.

Patterns can be switched live and are each up to four bars long. Four patterns plus one fill pattern are saved as one scene. 50 scenes can be permanently saved in the module. This means a total of 250 patterns are available.

Additional inputs and outputs are available for controls. There are four user-defined CV inputs, as well as two programmable analog clock outputs. On the front there are MIDI input and output as 3.5mm TRS-B sockets. Firmware updates can be done via MIDI-SYSEX.

# MODULE OVERVIEW

**1** I/O-JACKS:  
MIDI (Typ: TRS-B), Clock, Reset  
USER1+2 input, LFO1-4 outputs

**2** OUTPUTS:  
8x Gate/Trigger  
8x Velocity-CV/Modulation-CV

**3** POTs: Variation, Gatetime

**4** LFOs, SETUP & MIDI-Menu

**5** POTs: Beat, Velocity

**6** KEYS: Sensor-Set, Shots, Phrase, Bar

**7** KEYS: Play, Pattern, Scene

**8** KEYS: Record, Clear/Copy/Swap

**9** KEYS: Functions

**10** KEYS: Select tracks

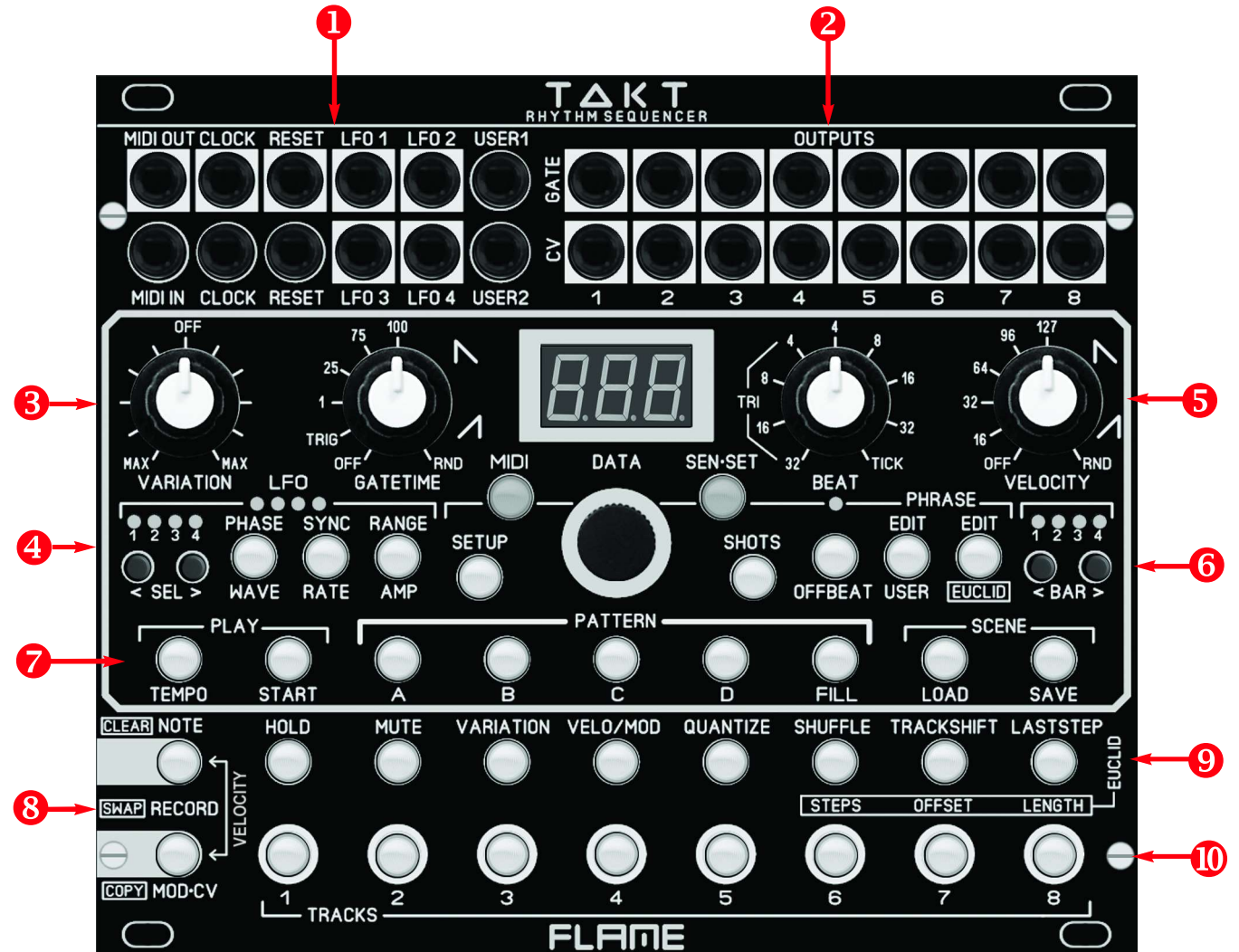

# CONNECTION TO THE MODULAR SYSTEM

The module is delivered with a connected ribbon cable for the Doepfer Buss. The colored wire indicates -12 volts.

It is important to pay attention to the correct polarity when connecting. If the module is accidentally polarized incorrectly, protective diodes prevent the module from being destroyed immediately (but it cannot be ruled out that damage will still occur).

**Therefore caution:** Check the connection several times before switching on for the first time!

The current consumption of the module is up to +130mA / - 30mA !

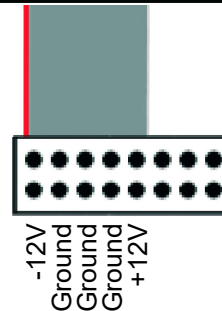

# CONNECTING THE SENSORS

The 2HP sensors are connected to the switched-off module via a 60cm long 6-pin ribbon cable. There are four box connectors for the cables on the underside of the module.

Since there are only pin contacts on the underside of the sensors, care must be taken to ensure correct polarity, otherwise the red LED could be damaged. The red marking on the cable must match the dot marking on the sensor connection!

## CAUTION:

Check the sensors before switching on for the first time!

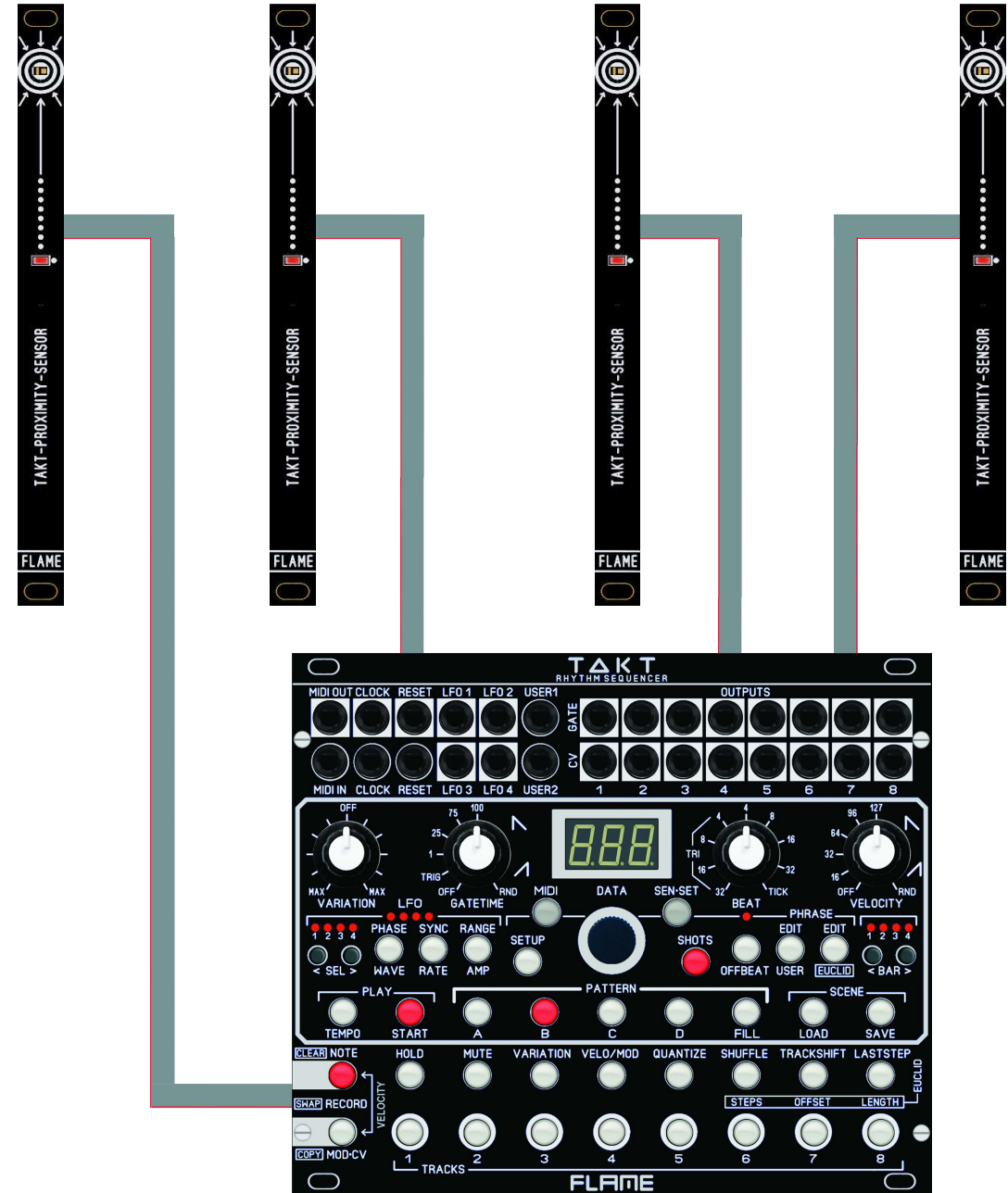
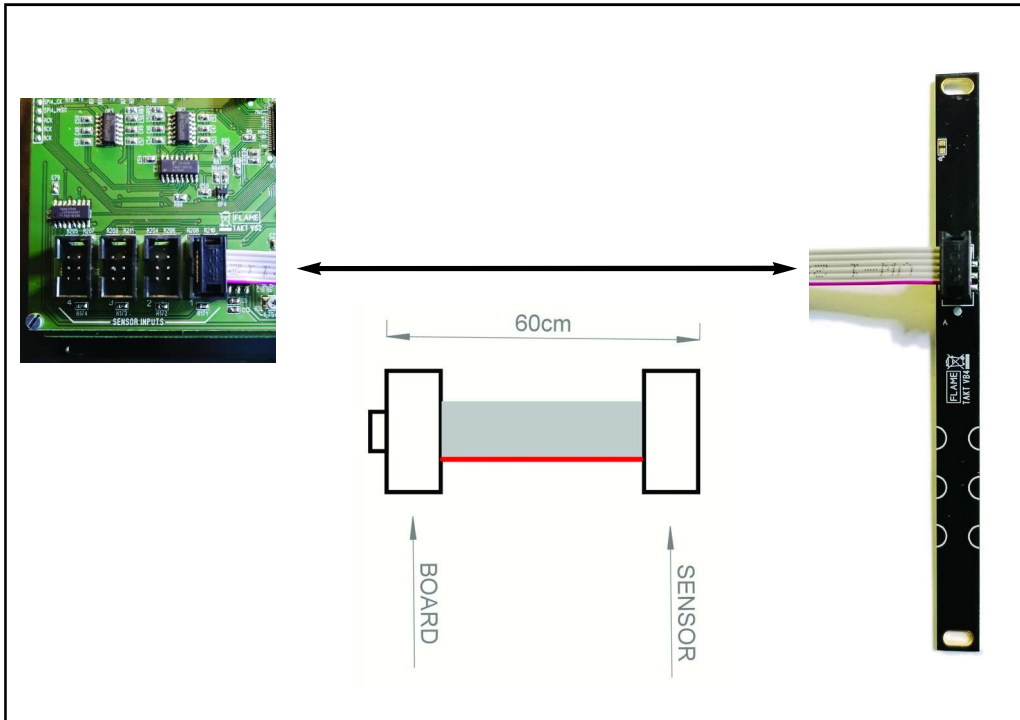

# FUNCTION OF THE SENSORS

With four sensors connected, the tracks can be played alternatively (as with the track buttons). If you move your hand over the sensor, the channel is triggered at a distance of approximately 7..10 cm. The red LED on the sensor lights up as long as the sensor is triggered.



The four sensors are permanently assigned to four channels.

However, the SEN-SET button can be used to switch between the assignment to channels 1-4 or 5-8.

If the LED is off (as shown above), then sensor 1 triggers channel 1, sensor 2 triggers channel 2, sensor 3 triggers channel 3, etc.

If the LED lights up, then sensor 1 triggers channel 5, sensor 2 triggers channel 6, sensor 3 triggers channel 7, etc.

## TURN OFF SENSORS

In certain situations it can be helpful to switch off the sensors so that no triggers are triggered. To do this, press and hold the SEN-SET button until it flashes. To reactivate the sensors, press and hold the SEN-SET button again until it stops flashing.

## SUN MODE

If the sensors are exposed to direct sunlight, they may trigger without being actuated. In this case, the sensitivity can be reduced in the SETUP menu so that the sensors also work correctly under these lighting conditions.

Go to SETUP - repeatedly press the SETUP button until the SUN menu appears on the display. Set the value with the data slider to "ON" and exit the menu again. The setting is permanently saved automatically.

**NOTICE:** In contrast to the track buttons or MIDI notes, which in SINGLE mode trigger the channel in real time and are later quantized in the loop, the triggers for the sensors are set and played for the next quantization step.

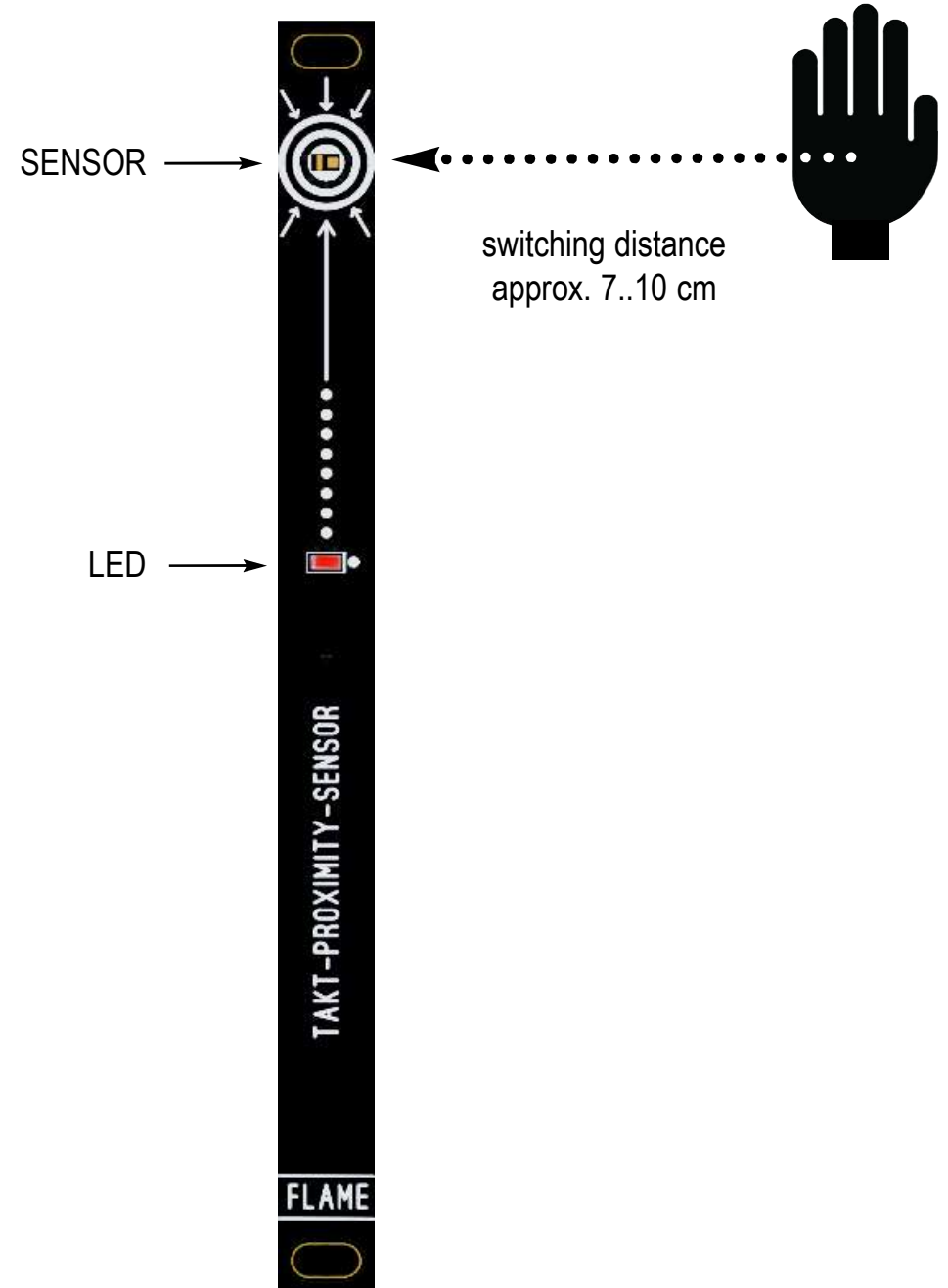

# TAKT BASIC STRUCTURE

Essentially the module consists of two parts:

## 1. Sequencer (Looper)

8 tracks with two outputs per track for trigger/gate and CV (velocity or modulation), as well as MIDI (note).

There are 5 patterns of 4 bars each available at the same time as a "SCENE". 50 scenes can be saved.

The resolution of the tracks is 96 ticks.

## 2. 4fold LFO

with separate outputs (bi- or unipolar), free-running, synced, or triggerable by notes on a track.

The looper's tracks are recorded either by 8 track buttons on the device or by four switchable external distance sensors or by received MIDI notes.

There are analog inputs and outputs for CLOCK and RESET signals respectively. There are also two programmable inputs USER 1+2 available for connecting foot pedals or gate signals.

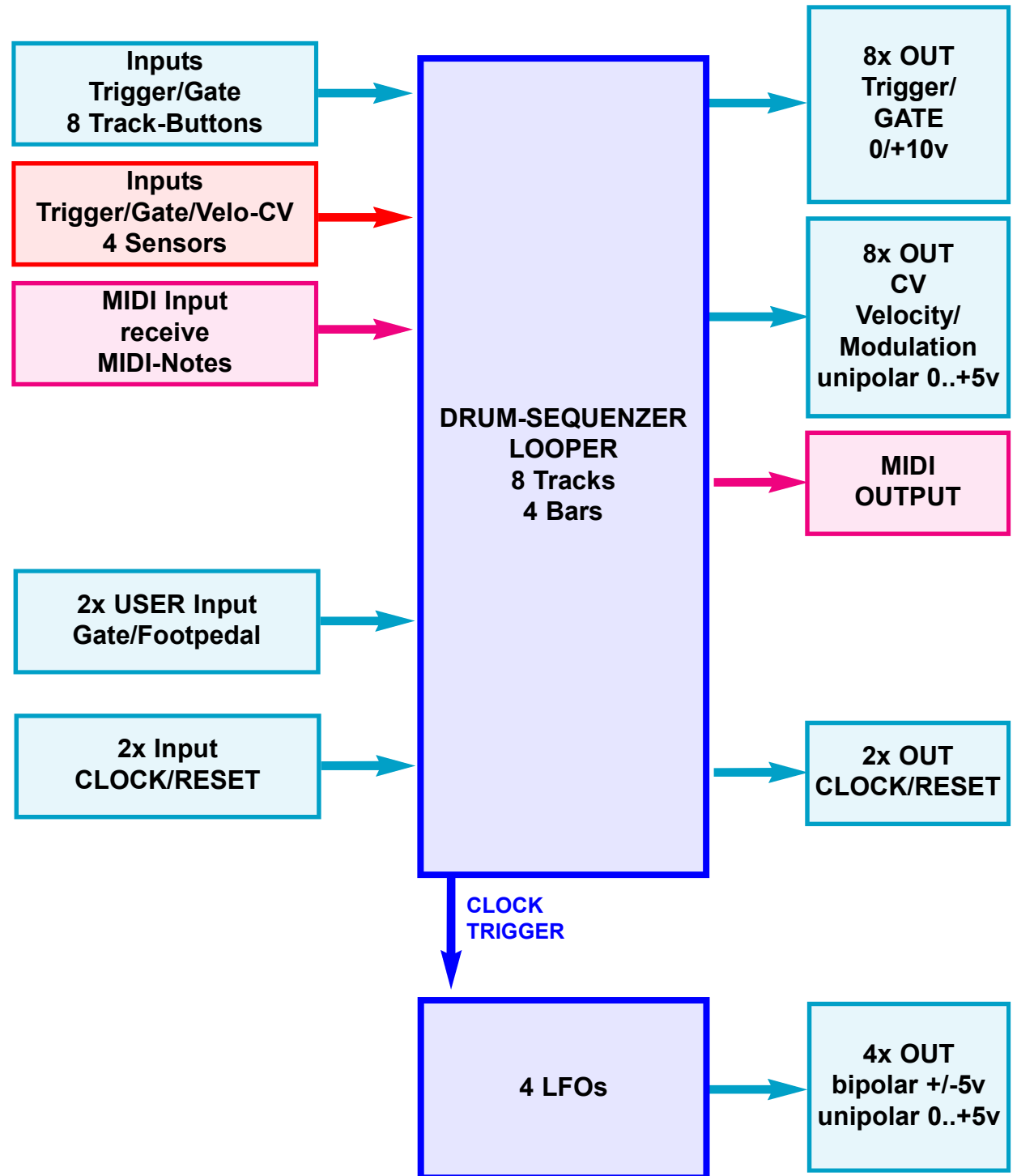



# MAIN MENUS

You can switch through the MAIN menus by pressing the corresponding button. This then lights up (or flashes).

The LFO buttons each have two functions. To select the function above the button, press the button for longer than one second. Then the button flashes. Values are then set using the data wheel and the value is shown on the display.

In the HOLD, MUTE and VARIATION function menus, the TRACK buttons are used to switch the function for the tracks on or off (the status is shown by the track button LEDs).

In the other function menus, the track for which the setting is made is selected using the track buttons.

The menus for editing the USER phrase and the EUCLID phrase have a special position and sometimes require all track and function buttons. To access these menus, press the corresponding button for more than one second. Then the button flashes. Values are changed in combination with the data wheel and/or the track and function buttons.

The EDIT USER Phrase Menu is basically an 8-channel, 16-step sequencer (see EDIT PHRASE chapter).

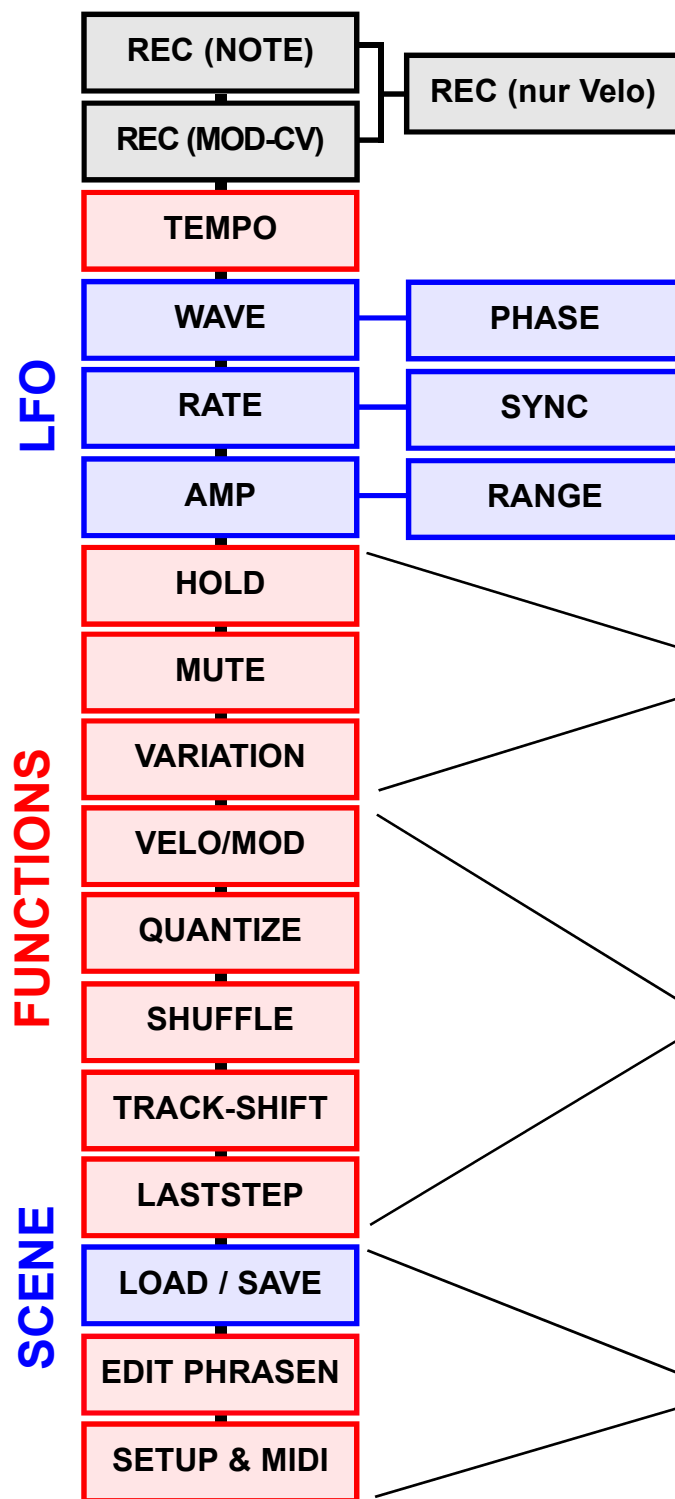

## “REC” (RECORD)

There are two RECORD buttons with three separate functions:  
 only NOTE on: Record of Note+Velocity  
 only MOD-CV on: Record the modulation CV  
 NOTE and MOD-CV on: Record only the velocity afterwards

“020” ... “200” Tempo in Bpm

see chapter LFO

“---” no values in the display

Use the track buttons to switch the function for the track on or off; the track button LEDs show the status.

Select the track with the track buttons, the button LED shows the selected track (with the exception of SHUFFLE). Set values with the DATA wheel. Details in the function chapters.

See the relevant chapters!

# SEQUENCER DATA STRUCTURE

## SCENE

The notes, velocity and modulation data are stored in a SCENE. A SCENE consists of 4 patterns A-D and a FILL pattern. This also includes the settings of all LFOs and the settings of the function menus (Hold, Mute, Variation, Velo/Mod, Quantize, Shuffle, Trackshift and Laststep). A maximum of 50 scenes can be saved in the TAKT.

When switching on, the scene preset in the SETUP menu is automatically loaded (AUTO-LOAD “ALd”).

## PATTERN

There are 5 loaded patterns within a scene. The structure of all patterns is the same. Each pattern can be up to 4 bars long (this applies to all patterns). Each pattern has 8 tracks with a maximum resolution of one MIDI tick. That's 96 steps per measure. Only one pattern can be played at a time. The pattern changes either to the next bar or “on the fly” immediately (can be set in the SETUP menu pattern change “PtC” either with “bAr” to the next bar or “FrE” Free=immediate). The following functions are available for organizing: delete a pattern, copy a pattern or swap two patterns.

## FILL PATTERN

The FILL pattern can always immediately interrupt a pattern that is currently running. As long as the FILL pattern is held down, only this pattern runs; when the button is released, the previous pattern runs. Switch to a different pattern (than the one before FILL) by pressing the new target pattern while FILL is active.

## TRACK

Each pattern consists of 8 tracks. A recorded note is played analogously as GATE via the GATE output socket with the velocity (volume) on the CV output socket (via MIDI as a NoteOn/NoteOff event). Each track can send and receive a specified note on a separate MIDI channel.

A note number must be set in the MIDI menu for each track. This note number is the same globally for all scenes.

The following functions are available for organizing track data:

delete a track, copy a track or swap two tracks.

# EDIT PATTERN, TRACK, STEP

## CLEAR FUNCTION (clear data)

While holding down the **CLEAR** button, press an additional key:

**Track keys 1-8:** deletes the step (trigger/gate) at the current position while the sequencer is running

(analogous to SHOTS/SINGLE record) unquantized

**Function keys 1-8:** deletes the corresponding track as follows:

delete all triggers/gates, switch off MUTE+HOLD, TRACK-SHIFT reset to 0, modulation track remains, Last step remains

**Pattern keys:** deletes the entire pattern, but only at STOP!

## COPY FUNCTION (copy data)

While holding down the **COPY** button, press additional key combination for:

**Copy Pattern:**

Use the pattern keys to press source and destination one after the other.

**Copy Track:**

Use the track buttons to press source and destination one after the other.

## SWAP FUNCTION (swap data)

While holding down both **COPY+CLEAR** keys, press an additional key combination for:

**Swap 2 patterns:**

Use the pattern keys to press source and destination one after the other.

**Swap 2 tracks:**

Use the track buttons to press source and destination one after the other.

# FUNCTIONS

The function menus are located on the 8 buttons above the track buttons.

The 8 function menus can be called up directly by pressing the corresponding button, unless EDIT PHRASE USER or EUCLID is switched on (PHRASE USER or EUCLID button flashes!) These must first be switched off again before the functions can be called up. The function settings are saved in the SCENE and are the same for all patterns in the scene.

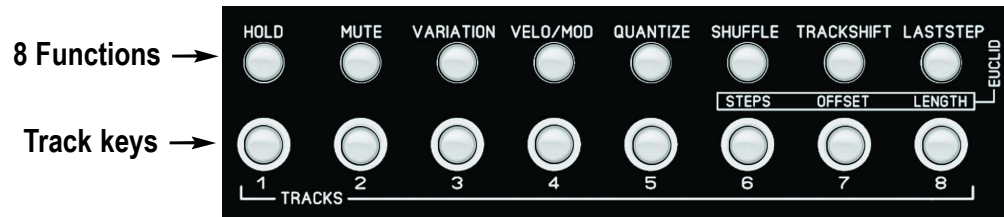

## HOLD

Press the HOLD button, the button lights up.

Use the TRACK buttons 1-8 to turn HOLD on/off for the track. The track button LEDs show the status, the display shows "---", the data controller has no function.

If HOLD is turned on for a track, it cannot be recorded. The recorded notes remain protected. But you can still play over it live.

## MUTE

Press the MUTE button, the button lights up.

Use the TRACK buttons 1-8 to turn the MUTE on/off for the track. The track button LEDs show the status, the display shows "---", the data controller has no function.

MUTE suppresses playback of the track. If MUTE is on for a track, it cannot be recorded. The recorded notes remain protected.

## VARIATION

Press the VARIATION button, the button lights up.

Use the TRACK buttons 1-8 to switch VARIATION on/off for the track. The track button LEDs show the status, the display shows "---", the data controller has no function.

VARIATION activates the VARIATION control for the track. All tracks where VARIATION is switched on are influenced together by the controller. The controller creates different random algorithms for velocity and triggers that affect the playing notes.

Effect of the controller setting:

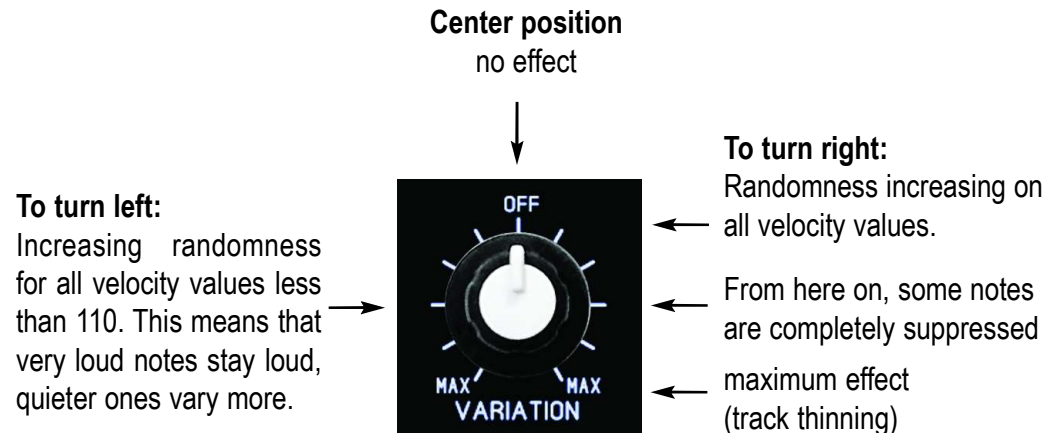

# FUNCTIONS

## VELO / MOD

Press the VELO/MOD button (above button 4), the button lights up.

Use the TRACK buttons 1-8 to select the track to be set, the corresponding track button lights up (only one track can be selected), and the value appears in the display. Change the value with the data controller.

This function determines what is output from the track's CV output jack. This can be the velocity of the note, a recorded CV modulation or one of 32 preset CV modulation sequences.

The following values are possible:

**uEL** = Velocity. The CV socket outputs velocity values.

**rEC** = Recorded modulation. The CV socket outputs modulation CV values.

**001** = No. of the preset sequence. The CV socket outputs modulation CV values.

This setting has no influence on the MIDI data. If there is no velocity coming out of the socket but modulation CV, the velocity will still be sent via MIDI.

## QUANTIZE

Press the QUANTIZE button, the button lights up.

Use the TRACK buttons 1-8 to select the track to be set, the corresponding track button lights up (only one track can be selected), and the value appears in the display. Change the value with the data controller.

This value determines whether and how the track is quantized automatically when recorded using SINGLE or SHOTS or using the BEAT control. If the value is switched off "oFF", the quantization depends on the value of the BEAT control. Here the tracks can be set to different values in order to be able to record and play simultaneously triggered tracks with different beats. In addition, "dotted notes" can be created that are not on the BEAT control.

The following values are possible for QUANTIZE:

**oFF** Quantization of the track is only determined by the BEAT pot.

The following values set the track to a fixed quantization:

**\_4d** quarter dotted  
**\_2t** half triplet  
**\_4** quarter normal  
**\_8d** eighth note dotted  
**\_4t** quarter triplet  
**\_8** eighth note normal  
**16d** 16th dotted  
**\_8t** eighth note triplet  
**16** 16th normal  
**16t** 16th triplet  
**32** 32th normal  
**32t** 32th triplet

Then the same order with the beat in the OFFBEAT, indicated by a dot at the end:

**\_4d.** quarter dotted, offbeat  
**\_2t.** half triplet, offbeat  
..... etc until  
**32t.** 32th triplet, offbeat

# FUNCTIONS

## SHUFFLE

Press the SHUFFLE button, the button lights up.

The value is shown in the display. Change the value with the data controller.

A 16th shuffle is set globally for the scene here. Every second 16th note is played delayed by a small amount.

Value range: **oFF, 001-127**

## TRACKSHIFT

Press the TRACKSHIFT button, the button lights up.

Use the TRACK buttons 1-8 to select the track to be set, the corresponding track button lights up (only one track can be selected), and the value appears in the display. Change the value with the data controller.

The track can be moved forward or back directly in eight 16th steps, and/or additionally fine-shifted in ticks. An integer in the display shows the value of the 16th shift, an additional fine shift is shown with a dot. The fine shift can be adjusted in a maximum of 6 ticks forward or backward while keeping the TRACK button pressed.

### 16th shifts with DATA pot:

- 0** switched off, track is not shifted
- 1 ... 8** Track pushed further in 16ths
- 1 ... -8** Track pushed back in 16ths

### Fine shift (in ticks) with DATA pot while holding down the track button:

- 0F** switched off, track is not finely shifted
- 1F ... 6F** Track pushed further in ticks
- 1F ... -6F** Track pushed back in ticks

If a track has been finely shifted, this will be indicated with a dot in the display at the "normal" 16th shift.

### EXAMPLES:

- 0.** 16ths switched off, but track also finely shifted in ticks
- 2.** Track moved two 16ths further and additionally fine-shifted in ticks

You can see the exact value of the fine shift by continuously pressing the TRACK button, for example:

**-3F** track pushed back 3 ticks

### A NOTICE:

If notes are re-recorded on a track that has already been moved, they will not appear as moved.

## LASTSTEP

Press the LASTSTEP button, the button lights up.

Use the TRACK buttons 1-8 to select the track to be set, the corresponding track button lights up (only one track can be selected), and the value appears in the display. Change the value with the data controller.

The last step determines the length of the bar in 16ths based on 1 bar. It is the same for all bars (bar), so it loops the same for all 4 bars.

Value range: **01-16**

# RECORDING

## SINGLE NOTES

Steps can only be recorded while the sequencer is running. Turn off the SHOTS button (not lit). Press the RECORD NOTE button to record with the track buttons.

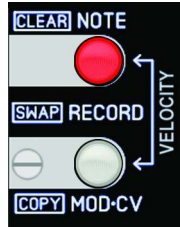

Start the sequencer and play with the track buttons, the sensors or a MIDI note via MIDI input. Beforehand, use the VELOCITY control to set the volume of the step (for MIDI notes, the received velocity is used). If a key is pressed briefly or long, a step is set on the next quantization step (note the BEAT control). It works the same way with the sensors or notes via MIDI input.

The gate time (length of the recorded note) depends on the duration of the key press. A very short key press creates a trigger (a few milliseconds). The GATETIME control is ineffective for single-note recording. As long as the button remains pressed, notes that have already been recorded will be deleted. If you play into a note that is already playing, the length of this note will only extend to the new note (1 tick before because of retrigger). If no note has been set yet, the gate extends over the entire loop. Notes played across a bar boundary are played truncated when the bars change.

## SHOTS RECORD (NOTE REPEAT)

SHOTS are running pulse phrases with different rhythms that can be recorded while the sequencer is running. The rhythm is determined by the BEAT control (grid, resolution) and the selection of USER phrase, EUCLID phrase or just BEAT.

To record notes in SHOTS mode, make the following settings:

- Switch to SHOTS (SHOTS button must light up)
- Switch to RECORD (RECORD NOTE button must light up)
- MUTE and HOLD of the track to be recorded must be switched off beforehand.

You can record with the track buttons, the sensors or with MIDI notes (via MIDI input). Example with track button: As long as the track button is pressed, a sequence is recorded that is determined by the BEAT settings, VELOCITY and GATETIME controls.

## VELOCITY

Determines the values for MIDI and CV velocity or modulation CV.

Fixed values from 0-127 up to the middle position, decreasing to the right, increasing, random values. The controller can also be used to record a modulation sequence independent of the trigger (see VELO/MOD function).

## GATETIME

OFF: for SHOTS: no steps are set = pause

TRIG: Gate length of only short triggers

1-100: The gate lengths depend on the BEAT (in percent)

up: The gate lengths are automatically generated from short to long

down: The gate lengths are automatically generated from long to short

RND: The gate lengths are randomly generated

## BEAT

The BEAT control determines the pulse sequences (divider) in tick resolution.

Left: Triplet notes

Right: straight (duolet) notes

The pulse sequence can be continuous or a mini-sequence (USER phrase, EUCLID phrase).

## OFFBEAT

The pulse sequence runs in offbeat mode (except for 32nds and ticks)

## PHRASE USER

The pulse sequence is a 16-step sequence (editable with EDIT-USER + 16 track and function button), but loops after 12 steps with triplet/dotted!

## PHRASE EUCLID

The pulse sequence is a Euclidean algorithm (editable with EDIT-EUCLID + 3 Euclid buttons)

# RECORDING

## VELOCITY RECORDING

The velocity of an already recorded track with note trigger and velocity values can be changed or adjusted later. Simply record other values using the velocity control.

To do this, the two RECORD (NOTE and MOD-CV) buttons must be pressed together (both LEDs light up). The sequencer is now in velocity recording mode. Now enter new velocity values using the track buttons or sensors without changing the set note triggers. The track must be set to "VEL" in the VELO/MOD function menu.

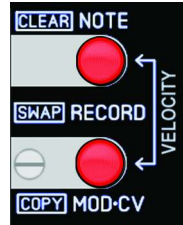

## MOD-CV RECORDING

Press RECORD MOD-CV/COPY button (button lights up):

A modulation sequence for the analog CV output can now be recorded. To do this, the track must be set to "REC" in the VELO/MOD function menu. This modulation sequence is only output via the track's CV output (not via MIDI). Velocity data is still sent via MIDI.

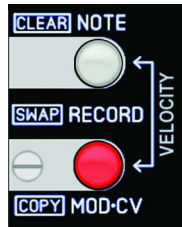

A continuous modulation movement can now be recorded with the VELOCITY control. To do this, first turn the BEAT control to "TICK" (highest resolution). If you want a gridded sequence, change the BEAT setting accordingly.

### Record, like this:

With the sequencer running and the track button (or active sensor) held down, turn the velocity control (or record an automatic velocity movement).

# EDIT PHRASE

## EDIT PHRASE USER

A 16-step sequence (editable with the 16 track and function buttons) can be programmed per scene for each track. This sequence can be used as a BEAT phrase for recording SHOTS. The resolution can be adjusted with the BEAT control. Switch to mode by holding down the EDIT USER button for longer than 1 second. This then flashes.

The following controls are effective:

- select track 1-8 with DATA control =, the display shows: "Tr1" (track + number)
- Switch steps 1-16 on/off with the 16 function and track buttons.

## EDIT PHRASE EUCLID

Euclidean sequences can be programmed per scene for each track. This sequence can be used as a BEAT phrase for recording SHOTS. The resolution can be adjusted with the BEAT control. Switch to mode by holding down the EDIT EUCLID button for longer than 1 second. This then flashes.

The following EUCLID parameters can be set:

- |                                                        |                            |
|--------------------------------------------------------|----------------------------|
| <b>Length:</b> Button LASTSTEP (Edit with Data pot)    | Display: "L16" (L + Steps) |
| <b>Offset:</b> Button Track-Shift (Edit with Data pot) | Display: "O 2" (O + Steps) |
| <b>Steps:</b> Button SHUFFLE (Edit with Data pot)      | Display: "S16" (S + Steps) |
- Select track with track buttons 1-8.

### A NOTICE:

When you EDIT the PHRASEs you can hear the phrase playing without it being recorded. Playback of recorded notes on the selected track is suppressed.

The track can also be selected using the sensors and external MIDI notes and then jumps to the channel. EDIT PHRASE cannot be recorded!!

All four controls VARIATION, GATETIME, BEAT and VELOCITY are effective when listening to the phrase. The EDIT function can also be selected for SINGLE NOTES (SHOTS switched off).

# LFO

There are four identical programmable LFOs for each Scene. Each LFO has WAVE & PHASE, RATE & SYNC and AMP & RANGE settings. The waveforms come in two variants: output bipolar or unipolar (and unipolar inverted). The LFO only has analog outputs and no MIDI functions. However, it can be triggered via track steps and synchronized to the MIDI clock. The speed can be adjusted between 40Hz and a duration of over 9 minutes.

4x LFO outputs



## SELECT LFO

Use the LFO SELECT button to select the LFO you want to edit. The LED signals the currently selected LFO. All changes to the values then only apply to this LFO.



## SELECT/EDIT LFO FUNCTIONS

Use the three LFO function buttons to select the function you want to edit. The button LED signals the function currently selected. Use the dial to change the value. To do this, proceed as follows:

You can access the WAVE, RATE, AMP functions labeled under the buttons directly by briefly pressing the corresponding button. This then lights up. The current value appears in the display. Change the value by turning the dial wheel.

To edit the functions PHASE, SYNC, RANGE labeled above the buttons, hold down the corresponding button for a little longer (approx. 1 second) until the button flashes. The value of the function now appears in the display. Turn the dial to change the value. To go back, briefly press the button again.

## Overview of the LFO functions

<b>WAVE</b>	26 waveforms
<b>PHASE</b>	Phase shift of the wave in steps of +/- 15 degrees
<b>RATE</b>	Speed
<b>SYNC</b>	synced to the clock / free running, or triggered by track OneShot
<b>AMP</b>	Waveform output voltage
<b>RANGE</b>	Output bipolar, unipolar or unipolar inverted



## LFO - WAVE (waveforms)

Each LFO has 26 different waveforms. Briefly press the WAVE button. Then, after releasing the button, change the waveform of the currently selected LFO by turning the dial.

The following waveforms are available:

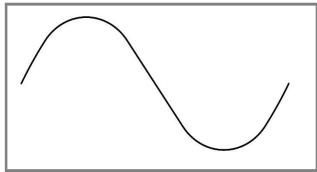

1. **Sin** (Sinus)  
Classic sine waveform. With the help of this waveform, floating or evenly rising and falling effects can be created.

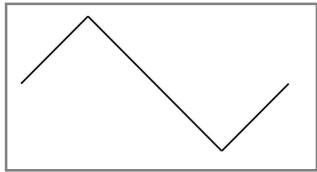

2. **tri** (Triangle)  
Classic triangle waveform. With the help of this waveform, floating or evenly linear rising and falling effects can be created.

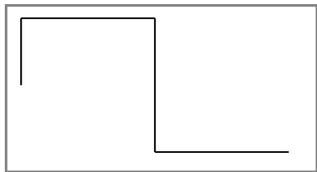

3. **Sqr** (Square)  
Square waveform with 50% duty cycle.

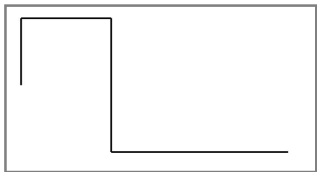

4. **PL1** (PULSE 1 - square wave pulse)  
Rectangle pulse waveform with a duty cycle of 30 to 70%.

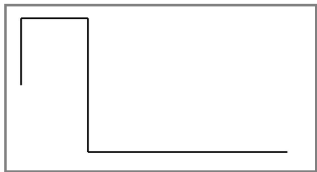

5. **PL2** (PULSE 2 - square wave pulse)  
Rectangle pulse waveform with a duty cycle of 25 to 75%.



6. **PL3** (PULSE 3 - square wave pulse)  
Rectangular pulse waveform with a duty cycle of 10 to 90%.

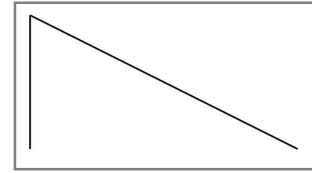

7. **do1** (Down 1 - falling sawtooth)  
Linear sloping sawtooth.

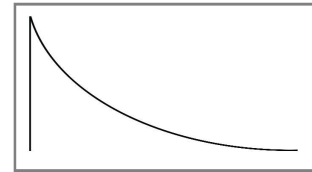

8. **do2** (Down 2 - Decay waveform)  
Logarithmic medium fast decay waveform (slowing down).

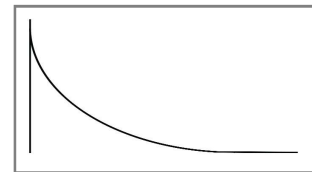

9. **do3** (Down 3 - Decay waveform)  
Logarithmically decaying decay waveform very quickly (slowing down).

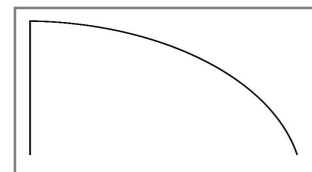

10. **doE** (Down Exponential - falling waveform)  
Exponentially decaying waveform (getting faster).

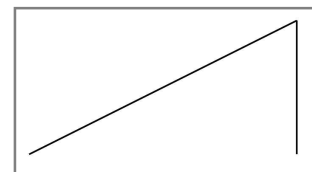

11. **UP** (rising sawtooth)  
Linear increasing waveform.

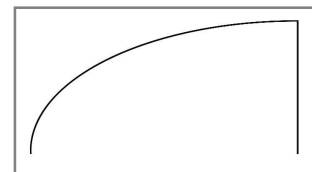

12. **UPL** (ascending waveform)  
Logarithmically rapidly increasing waveform (slowing down).

## LFO - WAVE (Wellenformen)

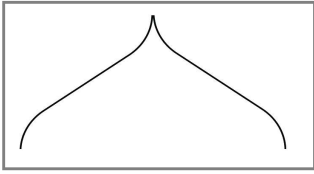

13. **d-1** (DIGITAL 1 - Sweep)  
Sinusoidal sweep for floating effects.

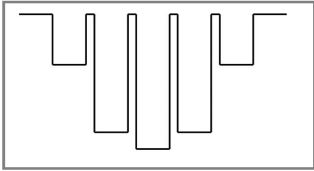

14. **d-2** (DIGITAL 2 - Reso)  
Resonating square waveform.

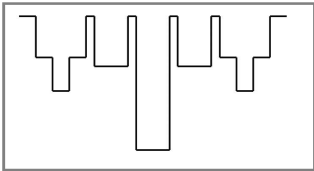

15. **d-3** (DIGITAL 3 - Reso)  
Resonating softer square waveform.

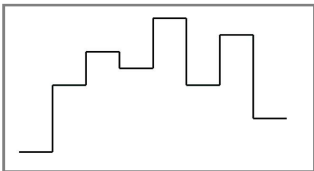

16. **SH1** (Sample & Hold 1 - Sequence)  
Even 8 step rectangle sequence.

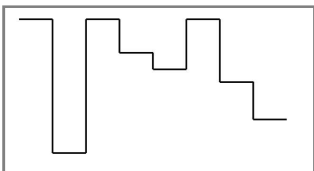

17. **SH2** (Sample & Hold 2 - sequence)  
Even 8 step rectangle sequence.

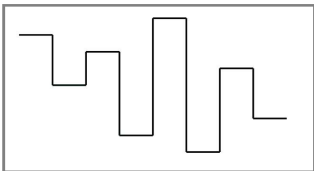

18. **SH3** (Sample & Hold 3 - Sequence)  
Even 8 step rectangle sequence.

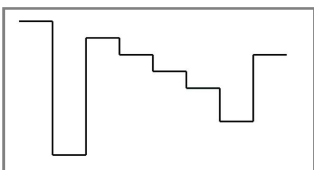

19. **SH4** (Sample & Hold 4 - Sequence)  
Even 8 step rectangle sequence.

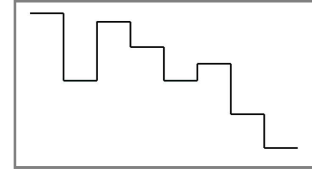

20. **SH5** (Sample & Hold 5 - Sequence)  
Even 8 step rectangle sequence.

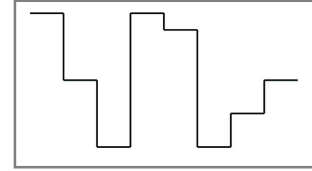

21. **SH6** (Sample & Hold 6 - Sequence)  
Even 8 step rectangle sequence.

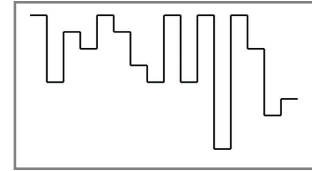

22. **SH7** (Sample & Hold 7 - Sequence)  
Even 16 step rectangle sequence.

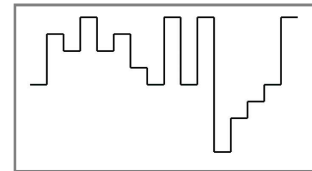

23. **SH8** (Sample & Hold 8 - Sequence)  
Even 16 step rectangle sequence.

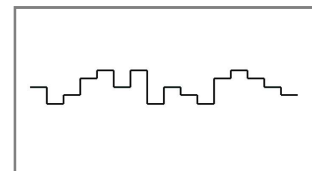

24. **SH9** (Sample & Hold 9 - Sequence)  
Uniform 16 step rectangle sequence with low dynamics.

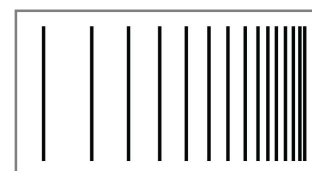

25. **bbA** (Bouncing Ball sequence)  
Short pulses getting faster.

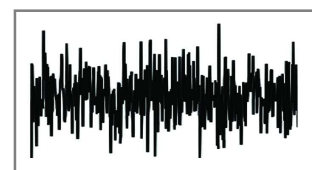

26. **rnd** (RANDOM)  
Random waveform (digital noise).  
During slow playback, sliding values due to interpolation  
(value smoothing).

## LFO - PHASE (Phase shift)

The start point of the waveform can be moved forward or backward in 15 degree increments. This allows, for example, counterclockwise waveforms to be realized at the same rate (180 degree shift).

The PHASE menu is the submenu of the WAVE menu.

Press and hold the WAVE button continuously. After approx. 1 second, the currently set phase of this LFO will be shown in the display. Change the value using the dial while holding down the WAVE button.

Value range: - 180° ... + 180° (in steps of 15°)

**0** no phase shift  
**180** shifted by half

### A NOTICE:

The LFOs are set to the set phase during a reset. If LFO Sync is turned on, the LFO is automatically reset to the clock according to the rate. Free running LFOs are only reset when starting and changing the pattern.

The change in phase only takes effect after a reset. A change in the rate in sync occurs at the next 16th and the LFO is resynchronized at the next bar.

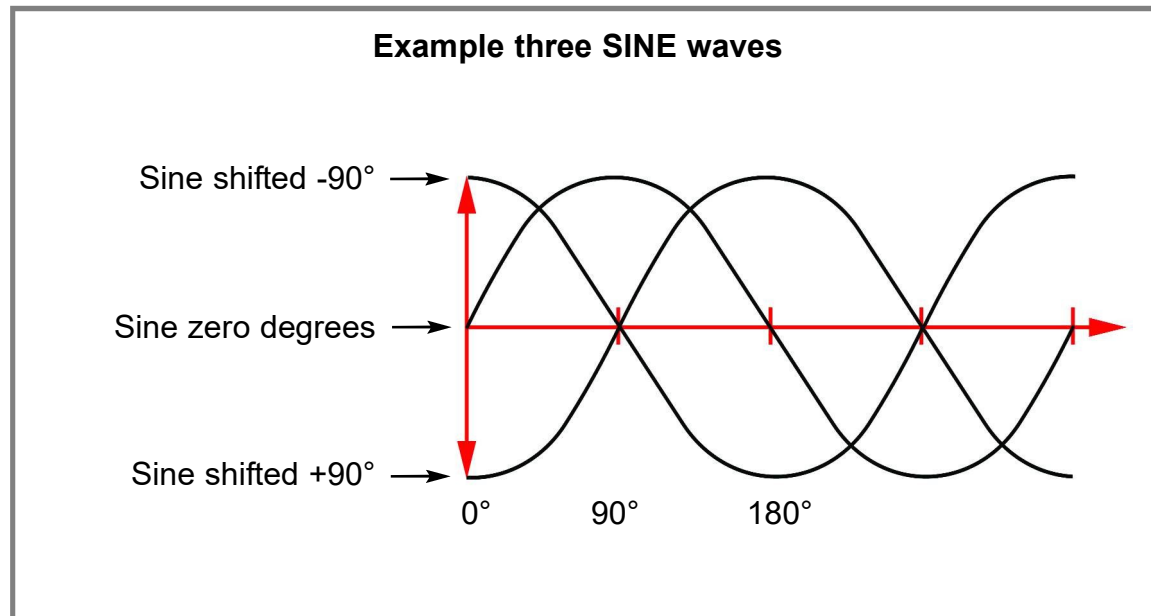

## LFO - RATE (speed)

The speed of the LFO is set in the RATE menu. In the SYNC submenu you can specify whether the LFO should run freely or be synchronized to the clock. The speed in free-running mode can range from several minutes duration to the lower audible audio range around 60Hz.

Press the RATE button once. The button now lights up. After releasing the button, the currently set value is shown on the display. Change the value using the dial.

Depending on the SYNC setting (see LFO - SYNC section), different value ranges are shown in the display:

### With SYNC = oFF

(Synchronization switched off, LFO free running)

Value range: **000...120**

**000** Speed a few minutes duration (approx. 9:50min)

**120** Speed approx. 40Hz

### With SYNC = on

(Synchronization switched on, LFO runs at musical intervals)

<b>4</b>	4 bars	<b>_4</b>	4th
<b>3</b>	3 bars	<b>_8.</b>	8th dotted
<b>2</b>	2 bars	<b>_4t</b>	4th triplet
<b>1</b>	1 bar	<b>_8</b>	8th
<b>_2.</b>	half dotted	<b>16.</b>	16th dotted
<b>1t</b>	1 bar triplet	<b>_8t</b>	8th triplet
<b>_2</b>	half	<b>16</b>	16th
<b>_4.</b>	4th dotted	<b>16t</b>	16th triplet
<b>_2t</b>	half triplet	<b>32</b>	32th

## LFO - SYNC (Synchronization, triggers)

In the SYNC submenu you can specify whether the LFO should run freely, be synchronized to the clock (in a loop) or be triggered by notes on a track.

The Menu SYNC is the submenu of Menu RATE.

Press and hold the RATE button for approx. 1sec. When the button flashes, release it again. The current setting for the synchronization of this LFO is shown in the display. Change the value using the DATA knob.

Value range: **on / oFF / tr1..tr8**

**on** Synchronization to the clock is switched on, the LFO is synchronized to the clock

**oFF** Synchronization to the clock is switched off, the LFO is free running

**tr1..tr8** LFO wave is triggered by notes on a track (sync'd OneShot)

## LFO - AMP (LFO amplitude=output level)

The outputs of the LFOs each run via a VCA and can therefore be attenuated electronically. The maximum output voltage is +/- 5V. Using the AMP settings, the output voltage can be varied over a wide range. It is also possible to control the amplitude using another LFO.

Press the AMP button once. The button now lights up. After releasing the button, the currently set value is shown on the display. Change the value using the DATA knob.

Value range: **oFF**, **001...059**, **LF1..LF4**

- oFF** the LFO level is zero volts
- 001..059** level setting between a few mV and max. 5V
- LF1..LF4** one of the three remaining LFOs controls the level:
  - with LFO-1 only LF2, LF3 and LF4 are displayed
  - with LFO-2 only LF1, LF3 and LF4 are displayed
  - with LFO-3 only LF1, LF2 and LF4 are displayed
  - with LFO-4 only LF1, LF2 and LF3 are displayed

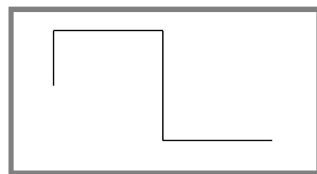

**LFO 1**  
Rectangle,  
Rate fast  
AMP=LF2 (LFO-2)

+

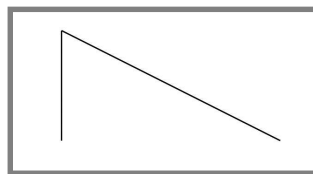

**LFO 2**  
Down linear,  
Rate slow

=

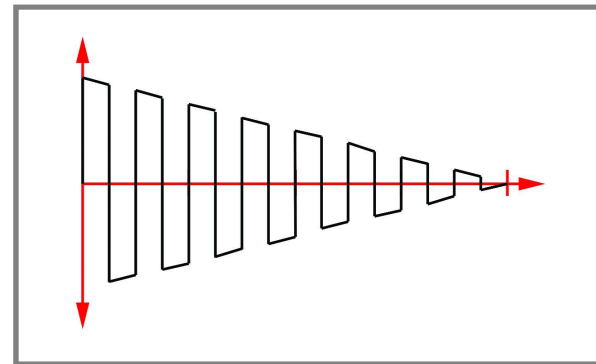

**Result at the output of LFO 1:**  
The output level is through  
LFO 2 modulates.

### A NOTICE:

If the LFO's VCA is controlled by another LFO, the entire stroke of the LFO wave affects the amplitude. The AMP setting of the other LFO is ineffective for this control. However, it still affects the output of the other LFO.

### EXAMPLE:

**LFO-1 with AMP=LF2 and LFO-2 with AMP=030**

The LFO-2 modulates the output level of LFO-1. This directly affects the output jack of LFO-1 with maximum amplitude of the waveform of LFO-2. The set amplitude of LFO-2 (value=030) only affects the output socket of LFO-2 and is attenuated by about half.

With the help of amplitude modulation by another LFO, slowly decreasing or increasing pulse sequences can be generated, for example!

## LFO - RANGE (voltage range)

In the RANGE submenu you can switch the LFO output to bipolar or unipolar.

The RANGE menu is the submenu of the Menu AMP.

Hold down the AMP button for about 1sec. When the button flashes, release it again. The current setting is shown in the display. Change the value with the DATA knob.

Value range: **bi** / **uni** / **Sid**

- bi** bipolar output voltage range max. between -5V...+5V
- uni** unipolar output voltage range max. between 0V...+5V
- Sid** SideChain: inverted unipolar output +5V...0V

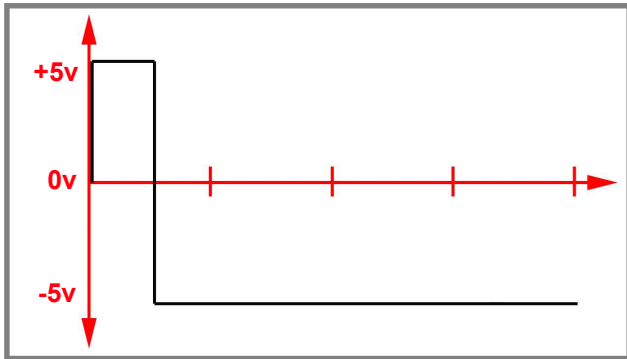

“bi”=bipolar

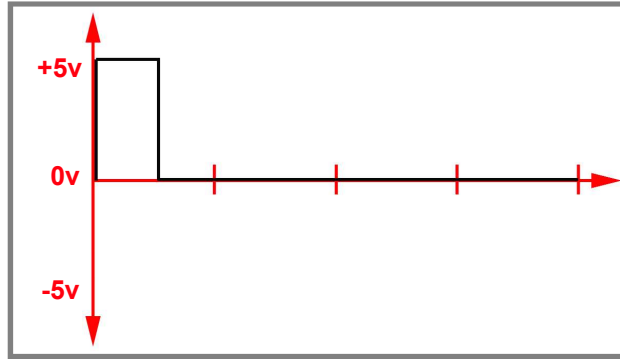

“uni”=unipolar

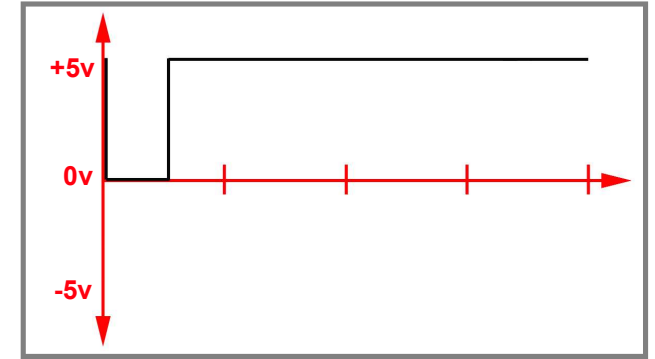

“Sid”=Side Chain  
unipolar-invers

# SETUP GLOBAL

Global settings are made in the SETUP menu, which apply to all scenes. Press the SETUP button to enter the menu. Step through the parameters by pressing the SETUP button several times. The display shows the menu name and the associated value by flashing. Change the value with the DATA controller. When the value is changed, the SETUP settings are automatically saved permanently.

The following parameters can be set:

**"USr"** - Assignment of the USER 1+2 sockets

**"FSn"** (USER1=FILL function, USER2=SENS-SET function)

**"SCE"** (USER1=Scene down, USER2=Scene up)

**"FCL"** (USER1=FILL, USER2=Clear Position)

**"CLi"** - Function of the CLOCK input socket

**"oFF"** (no function)

**"16"** (16th clock = 4 PPQN)

**"96"** (96 ticks per bar = 24 PPQN)

**"CLo"** - Function of the CLOCK output socket

**"oFF"** (no function)

**"16"** (16th clock = 4 PPQN)

**"96"** (96 ticks per bar = 24 PPQN)

**"rSI"** - Function of the RESET input socket

**"oFF"** (no function)

**"rES"** (trigger pulse reset sequence)

**"trS"** (trigger start/stop)

**"run"** (Toggle: high=Play, low=Stop)

**"rSo"** - Function of the RESET output socket

**"oFF"** (no function)

**"r01".."r32"** (reset after 1-32 cycles = short trigger pulse)

**"trS"** (sends trigger at start and stop)

**"run"** (toggle at play=high, stop=low)

**"PtC"** - Pattern change per beat or on the fly

**"bAr"** (pattern change to the next bar)

**"FrE"** (Free - pattern change immediately)

**"bCo"** - Auto BAR Copy

**"On"** (switched on)

**"oFF"** (switched off)

Auto Bar-Copy is the automatic copying of the bars into the remaining bars with the following BAR settings:

BAR=1            Bar 1 is also copied to bar 2,3,4 (when changing bar to 2 or 4)

BAR=2            Bars 1+2 are also copied to 3+4 (when bar changes to 3)

BAR=3+4        do nothing!

**"ALd"** - Auto load (Scene which is loaded when switching on)

**"01-50"** (Scene number 01-50)

**"SUn"** - Sensor setting for indoor/outdoor operation to avoid interference from the sun

**"On"** (sensors less sensitive)

**"oFF"** (sensors more sensitive)

# MIDI SETUP

MIDI settings are made in the MIDI menu, which apply to all scenes. Note that some MIDI parameters can be set differently for the patterns' tracks.

Press the MIDI button to enter the menu. Step through the parameters by pressing the MIDI button several times. The display shows the menu name and the associated value by flashing (except MIDI dump). Change the value with the DATA controller. If necessary, select the track using the track buttons.

When the value is changed, the MIDI settings are automatically saved permanently. The MIDI menu also contains the function for loading and saving a scene via SYSEX dump.

The following parameters can be set separately for the tracks:

<b>"rCh"</b> - MIDI receive channel of the track	Value range <b>"1-16"</b>
<b>"tCh"</b> - MIDI send channel of the track	Value range <b>"1-16"</b>
<b>"not"</b> - Note: MIDI note number of the track	Value range <b>"0-127"</b>

The following additional global parameters can be set:

<b>"rPr"</b> - ProgChange receive MIDI channel	Value range <b>"oFF, 1-16"</b>
<b>"SPr"</b> - ProgChange transmit MIDI channel	Value range <b>"oFF, 1-16"</b>
<b>"rCL"</b> - MIDI-CLOCK receiving	Value range <b>"On/oFF"</b>
<b>"SCL"</b> - SEND-CLOCK (Midiclock send)	Value range <b>"On/oFF"</b>

## SYSEX dump of a SCENE

The currently loaded Scene can be saved to a computer. To do this, go to the MIDI menu and step to the last parameter **"SSC"** / **"rSC"**. Switch between both functions by turning the DATA knob.

**"SSC"** - Dump Scene: Send Scene via SYSEX via MIDI-OUT

Here the scene can be sent via MIDI-OUT as a SYSEX file. Start sending by pressing the DATA control. The progress of sending will flash on the display. Sending takes approx. 40 seconds.

**"rSC"** - Dump Scene: Receive Scene via SYSEX via MIDI-IN

Here a Scene SYSEX file can be loaded via MIDI-IN. Start sending the SYSEX file on your computer. Reception will flash in the display. After receipt, the scene is in memory and must be saved to a scene storage location in order to remain permanently in the module.

Also note that receiving the Scene will overwrite the currently loaded Scene.



# FIRMWARE UPDATE

A computer with a MIDI interface and a SYSEX program is required for a firmware update. For PC we recommend the freeware software MIDI-OX, for MAC the software "SYSEX LIBRARIAN".

Proceed as follows:

- 1 Load the firmware file (e.g. FlameTaktV1\_3.syx) onto the computer.
- 2 Connect the MIDI input of the module directly to the MIDI out of your computer using a MIDI-TRS-B adapter (avoid detours, e.g. via USB hubs).  
**Advice:** A MIDI-TRS-B adapter is required for the MIDI connection!
- 3 Turn on the module while holding buttons MOD-CV and 8 (TRACK 8). The module now starts in the bootloader menu and waits for the Sysex file. The display shows: "UPd" (Update)

Send the firmware file from the sysex program to the module. The receipt of the data should now be shown on the display of the module (counter counts up). If nothing is shown on the display when sending the file, the MIDI connection is not correct (please check the cables, settings of the MIDI interface and SYX program settings).

If the upload was successful, the module saves the data (the display freezes for 2-4 seconds) and then starts automatically with the new firmware.

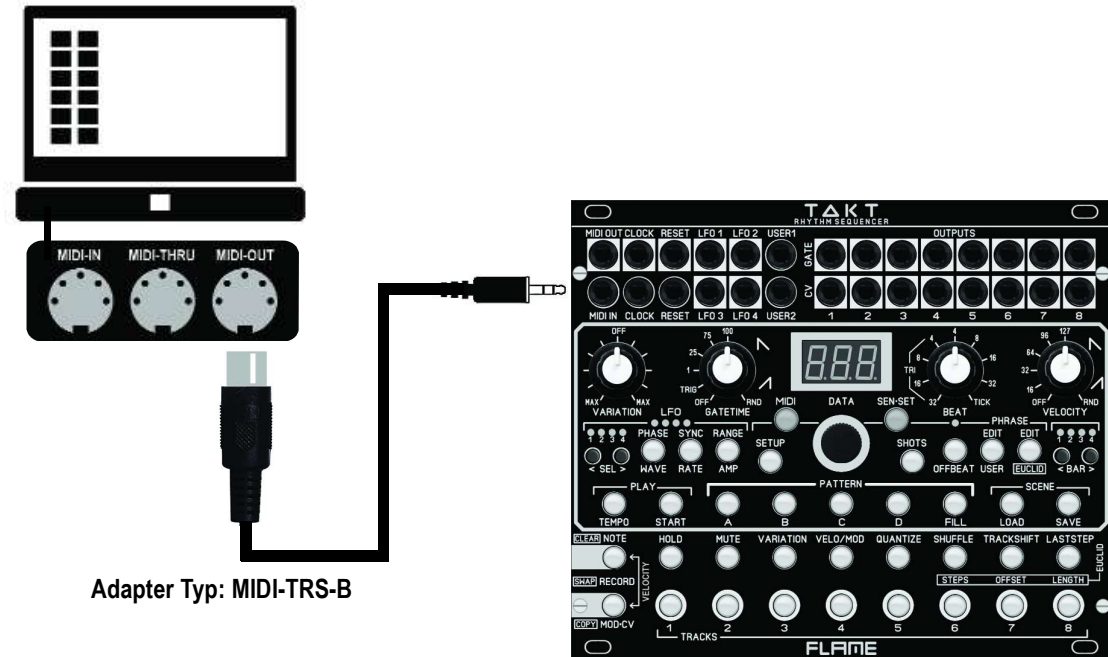

# QUICKSTART

TAKT comes pre-installed with 4 simple patterns on Scene 1 in order to simplify you starting off with your modular, making sure everything is connected correctly and so that something happens right away. These patterns are also perfect for exploring the various functions of TAKT. Clocks and Resets are also set up to work straight out of the box.

## A possible patch to start with would be:

Gate 1 > kick drum

Gate 2 > snare or clap

Gate 3 > envelope (e.g. to modulate the cutoff of a filter)

Gate 4 > hihats

Gate 5 > toms or percussion

## Let us show you a classic example!

**1** Save scene 1 as scene 2 by pressing SCENE / SAVE (centre right). Select 2 with the dial (in the middle of the module) and press SAVE again. Behind the 2 you'll see a dot appearing. When the dot stops flashing resp. goes out, the scene is saved.

**2** Now delete the 5 patterns by holding down CLEAR (bottom left) and pressing pattern 1, then 2, and so on - once. These patterns are now empty and you can start off fresh. At this point you could also setup TAKT so it always loads an empty scene when it powers up. Save the scene and then press SETUP eight times until the display shows "aLd" (autoload) - select the scene you want and exit the menu by pressing TEMPO or NOTE / CLEAR. Btw, that way you exit all menus in TAKT.

**Important:** Deleting patterns only works while TAKT is not running, deleting notes or tracks works always.

**3** Let's start with a simple 4/4 kick on track 1. When restarting, TAKT is always in **single mode** (the button to the right of the display). This means: when pressed, it will record. However, we first want to make sure that the kick actually lands on track 1, and this is how it works:

- Set the BEAT pot to 4, VELOCITY pot to 127, GATETIME pot to 1.

- Press the SHOTS button (it lights up and TAKT is now in **shots mode**).

While TAKT is running hold down the first track button for the whole bar. Now 4 exact quarter notes resp. kick drums have been recorded.

**4** We go over to the next parts, let's assume it's the hihats on track 4. Set the BEAT pot to 16th notes and press track key 4 continuously as in the previous example. By the way, you can of course also use the sensors instead. **Important:** it must be attached to the right slot and the pairs have to match (SEN-SET button!) as well.

**5** Let's assume you want to delete one or more notes within a track: hold CLEAR (left) and use one (or more) of the lowest eight keys to delete – as long as you press it! If you hold them continuously, all note values will be deleted, but just the note values – not the settings (mute, velocity, etc). If you want to delete the whole track (including mutes etc.) hold CLEAR and use the 8 keys in the second row from the bottom, this re-initialises the track. This also works while the sequencer is running, only in order to delete patterns the sequencer must be stopped.

**6** Now let's record a snare or clap on track 2, but this time in single shot mode. To do this press SHOTS once (now it's unlit) then press track button 2 whenever you want a snare being played. You could do the same on track 5 too and add a short roll with some percussion towards the end of the bar. If you're not sure anymore where your 1 is just restart TAKT and off you go.

Et voila! Don't forget to save the scene!

## HINT

When you record a track with SHOTS (when a track button is held down), you can simultaneously turn the BEAT knob and play rhythm patterns on the fly. Just give it a try!

# TROUBLESHOOTING

## **If nothing gets recorded, but you could hear the changes while recording:**

Make sure that MUTE & HOLD isn't active on that particular track. HOLD has to be unlit in order to record, otherwise you're only performing your change, but not recording it – which is great, when intended ;) And MUTE states should be obvious.

## **If TAKT still isn't recording:**

Check if the gatetime and velocity (only relevant for Midi or if CV is connected to Velocity of a VCAS) knobs are in their middle position. Just move both knobs a few millimetres back and forward. Usually that should quickly become part of your muscle memory, but it can be confusing sometimes, especially when starting off.

## **I'm playing several notes but only a few get recorded:**

Make sure that resolution is set to 16th notes, which is always a good starting point anyway..

## **My recording sounds wonky:**

Either the resolution is set to max (BEAT pot fully cw = TICK) hence you're recording unquantised, or the BEAT pot is set to triplets (the morning hours). Or you've accidentally pressed the offbeat button.

## **I can't delete the pattern:**

Make sure the sequencer is not running.

## **I deleted some notes, but something is still off?**

You probably deleted notes only (CLEAR & lowest row - the track buttons - only deletes the note). Hold CLEAR and press the according button in the second lowest row (the function buttons) in order to initialise that track.

## **I don't know how to exit a menu:**

Press TEMPO or NOTE (both left)!

## **The sensors play by themselves or interfere because I accidentally trigger them when wiring:**

Press and hold the SEN-SET button until it flashes. Now the sensors are switched off and cannot trigger any notes. To activate, press the button again until the flashing stops.

# APPENDIX & TECHNICAL DETAILS

## Technical details

### Connections:

Ribbon cable adapter for Doepfer bus +/-12Volt

Inputs: MIDI-TRS-B, Clock, Reset, 2x CV/Pedal, 3,5mm mono/stereo jacks

Outputs: MIDI-TRS-B, 12x CV, Clock, Reset, 8x Trigger, 3,5mm mono/stereojacks

### Controls:

41 buttons

4 Potentiometer, 1 encoder

1 LCD-graphic display

**Resolution:** DAC: 16Bit, CV Range: 0..+5V and +/-5V

**Current consumption:** +130mA / -30mA

**Size:** Euro format 3U / 30HP 152x128,5x33mm, installation depth: 43mm

## Warrenty

Beginning from the date of purchase a 2-year warranty is guaranteed for this device in case of any manufacturing errors or other functional deficiencies during runtime.

The warranty does not apply in case of:

- damage caused by misuse
- mechanical damage arising from careless treatment (dropping, vigorous shaking, mishandling, etc)
- damage caused by liquids penetrating the device
- heat damage caused by overexposure to sunlight or heating
- electric damage caused by improper connecting (wrong power supply/ jacks/ MIDI connections/ voltage problems).

If you have any complaints please contact your dealer or send an e-mail to:

**service@flame-instruments.de**

## Terms of production

conformity: CE, RoHS, UL

## Disposal

The device is produced with RoHS-conformity (subject to the regulations of the European Union) and is free of hazardous substances (like mercury, plumb, cadmium and hexavalent chrome). But electronical scrap is hazardous waste. Please don't add this to consumer waste. For an environment friendly disposal of waste please contact your distributor or specialist dealer.

## Support

Updated and additional informations, updates, downloads and more see: <https://www.flame-instruments.de>

## Acknowledgment

For help and assistance big thanks to: Sebastian Preller, Thomas Wagner, Felix Bergleiter, Anne-Kathrin Metzler, Alex4 and Schneiders Büro Berlin.